



# SS79HFD

Toyota Land Cruiser 70 series (Wide Nose)  
 Suits: 4.5L V8 D-4D Turbo Diesel (1VD-FTV engine)  
 Replaces Factory Toyota Raised Air Intake (Genuine Snorkel)



19/03/2011

## Parts List

ITEM	PART NO	DESCRIPTION	QTY
1	330-133-700	BODY - SNORKEL (SS76HF)	1
2	000-135-800	3.5" AIR RAM ASSEMBLY	1
3	330-032-700	BRACKET - UPPER MOUNTING	1
4	000-002-100	BOLT - HEX - 6mm x 1.0 x 14mm (SEMS)	2
5	000-951-300	SCREW - S/T - 4.2mm x 16mm - S/S	3
6	000-960	INSERT - PLASTIC	3
7	000-110	STUD - 8mm x 1.25 x 25mm - S/S	5
8	000-311-300	WASHER - BODY - 8mm x 30mm - S/S	5
9	000-205-300	NUT - NYLOC - 8mm x 1.25mm - S/S	5
10	330-435-000	RUBBER PAD	1
11	330-704-000	PLATE - BLANK-OFF	1
12	000-376	WASHER - RUBBER - 8.5mm x 33mm	1
13	330-024-800	HOSE - AIR ENTRY	1
14	000-909	CLAMP - HOSE - 80/100mm	2
15	000-914/B	CLAMP - HOSE - No.56 (BLACK)	1
16	330-017-700	TEMPLATE - GUARD PANEL	1



# SS79HFD

Toyota Land Cruiser 70 series (Wide Nose)  
Suits: 4.5L D-4D V8 Turbo Diesel (1VD-FTV engine)  
Replaces Factory Toyota Raised Air Intake (Genuine Snorkel)

## Installation Guide

### Fitment to:

- Right Hand Side

### Fitting Time:

- 150 min

### Special Tools:

- 86mm Hole saw
- Body Saw (Reciprocating)
- Step Drill
- Loctite 243 (Thread Lock)
- 6.5mm Drill Bit
- Masking Tape
- Touch-up Paint
- Prep-wash
- Sikaflex 227 Adhesive Sealant

Prior to commencing the installation, it is the installer's responsibility to verify that all components and particularly the guard panel template (Item 16) are correct.

1 Remove the following in accordance with the factory service manual:

- Air Cleaner Assembly

2

Remove and discard the Factory Toyota Raised Air Intake components (shown).

The following hardware must be retained, two A-pillar bracket mounting bolt assemblies and the rear mounting bolt assembly as shown.



3

The two factory mounting nut assemblies shown, which are spot welded to the inside of the guard panel must be removed.

Drill a pilot hole in the centre of each spot weld retaining the mounting nut assemblies to the guard panel, use a 6.5mm drill bit to drill out the spot welds.

Use a small pry bar or flat blade screwdriver to break the spot welds from the guard panel and remove the mounting nut assemblies.



4

Cover the main hole in the guard panel with masking tape.

Align the guard panel template (item 16) to rear and upper edges of the right hand guard panel.

Tape the template to the guard panel with masking tape, mark all five mounting hole positions the two hole saw centres and the upper and lower cut out sections with a felt tip pen.

Remove the template.

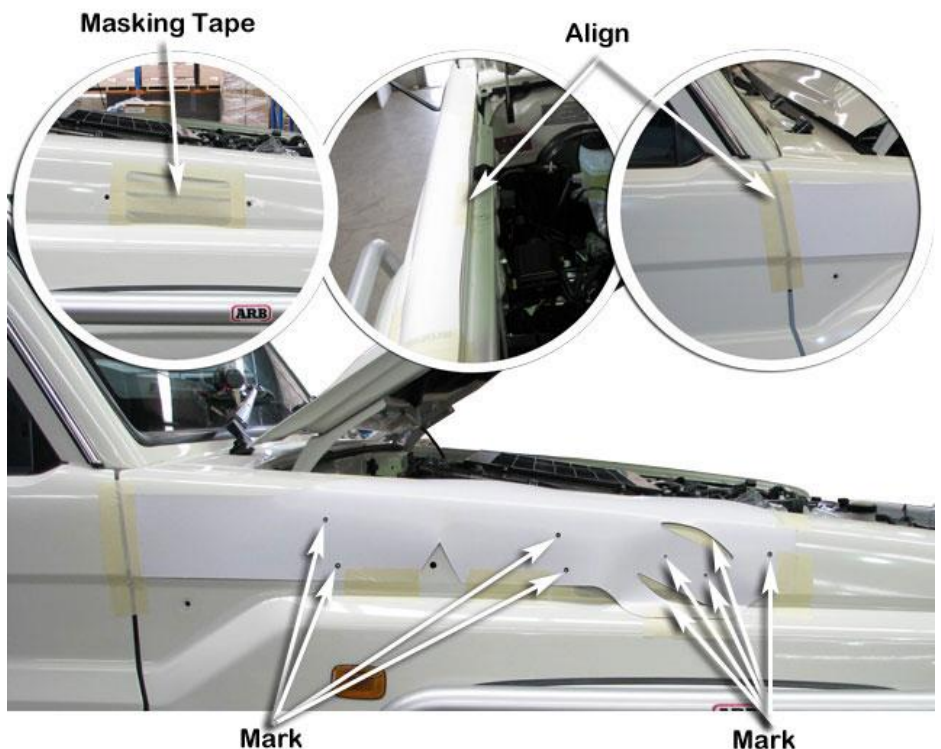

5

Align the 86mm hole saw centrally over the marked hole saw centre positions, mark around the outside of the hole saw with a felt tip pen as shown.



6

Use the body saw to trim away the marked section of guard panel.

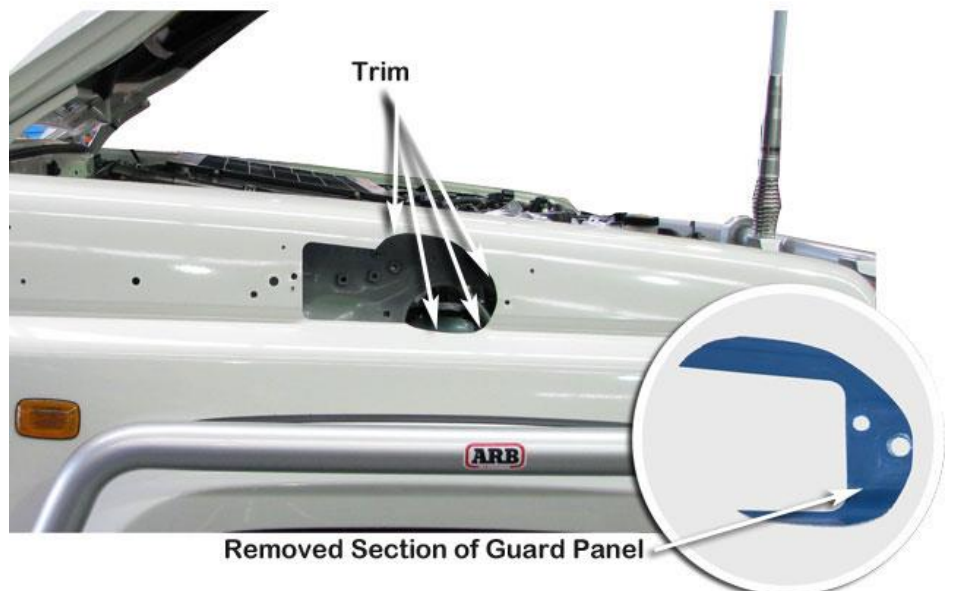

7

Drill a pilot hole for each of the marked hole positions.

Use a step drill to drill the five mounting hole positions to 16mm diameter.

Deburr and paint all holes to prevent rust.



8

Install the upper mounting bracket (item 3) to the snorkel body (item 1) with hex bolts (item 4).

Apply loctite 243 to each of the stainless steel mounting studs (item 7) and install the studs finger tight into the snorkel body (item 1) mounting inserts.

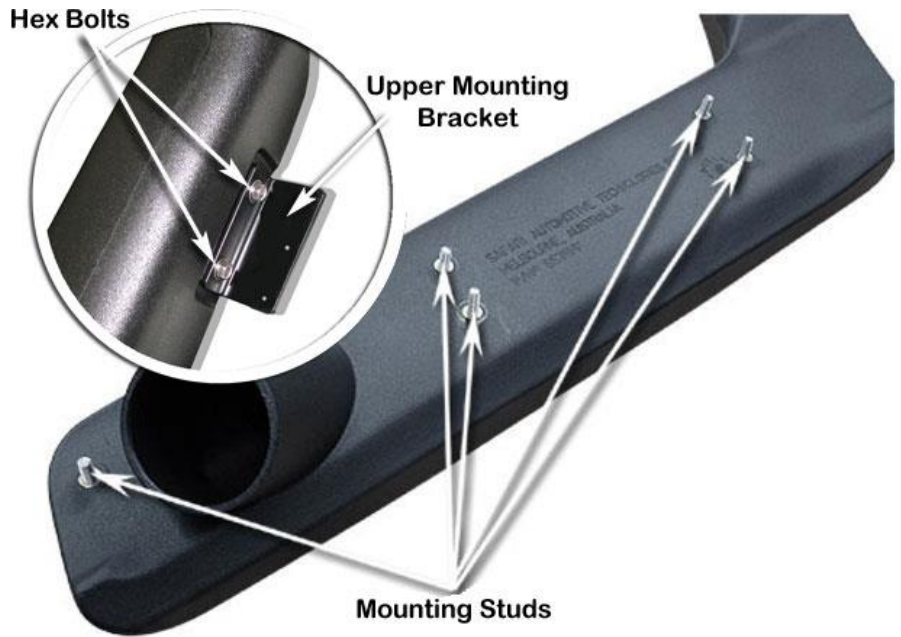

9

Place a strip of masking tape along the A-pillar panel.

Carefully install the snorkel body (item 1) to the guard panel.

With the snorkel body correctly positioned, mark the three upper mounting bracket hole positions onto the masking tape as shown.

*Hint: if necessary push the top of the snorkel body towards the windscreen rubber, so that the edge of the upper mounting bracket has approximately 1mm gap to the windscreen rubber.*



Mark Hole Positions

10

Remove the snorkel body (item 1) from the vehicle and remove the upper mounting bracket (item 3) from the snorkel body.

Drill a pilot hole at each of the three marked hole positions.

Drill each hole position to 8mm diameter with a step drill or 8mm drill bit.

Deburr and paint holes to prevent rust.

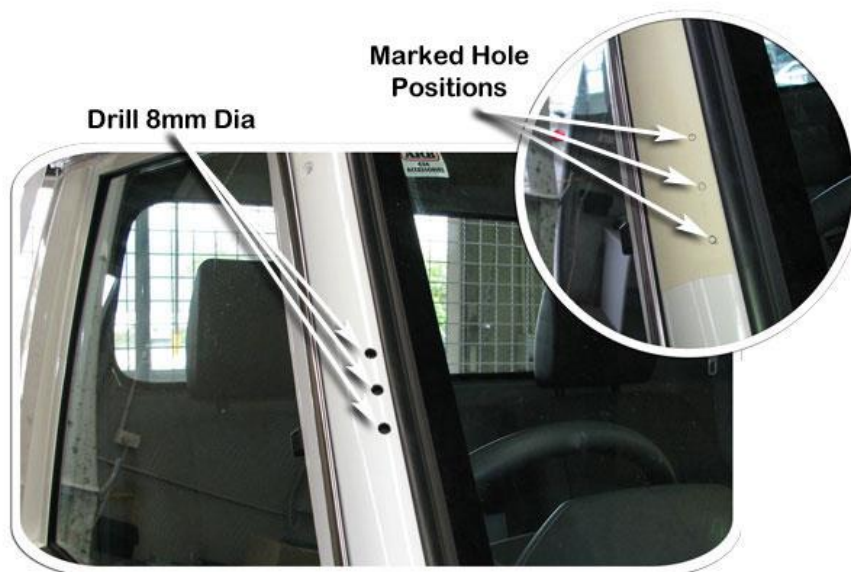

11

Install the plastic inserts (item 6) into the 8mm diameter holes in the A-pillar.

Secure the upper mounting bracket (item 3) to the A-pillar with three stainless steel self-tapping screws (item 5).

Install the blank-off plate (item 11) and rubber pad (Item 10) to the A-pillar, secure with standard Toyota bolt assemblies removed in step 2.

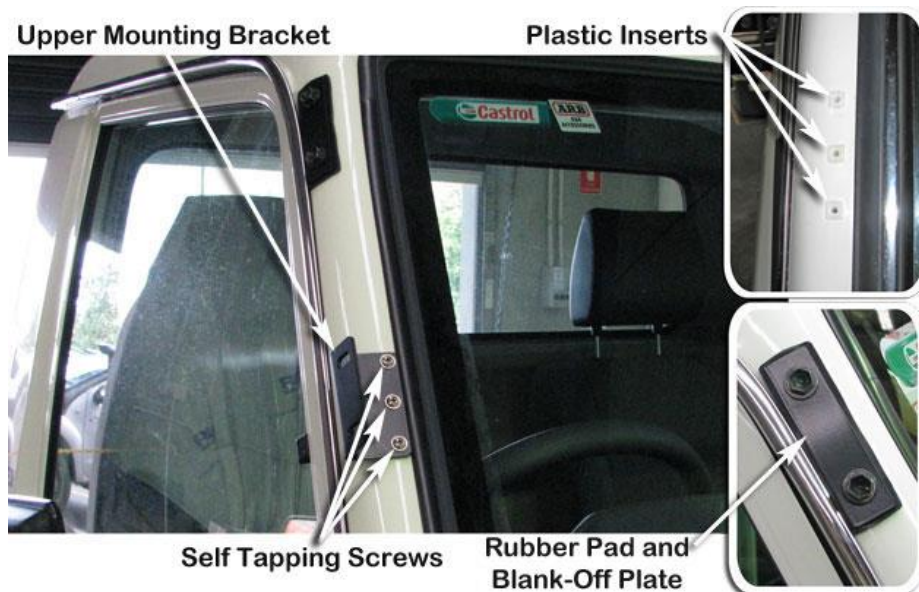

12

Carefully install the snorkel body (item 1) to the guard panel and align the snorkel body to the guard panel and upper mounting bracket.

When correctly aligned, fasten the snorkel body to the guard panel with body washers (item 8) and nyloc nuts (item 9).

Fasten the snorkel body to the upper mounting bracket with hex bolts (item 4).

Install the rubber washer (item 12) to the standard Toyota bolt assembly removed in step 2 and fasten into the lower mount hole in the guard panel.



13

### INSTALLER OPTION

The air cleaner housing base contains a drain valve as shown. The drain valve can permit water to enter the air intake.

It is up to the installer to decide whether the drain valve should be sealed.



14

Install the air entry hose (item 13) to the air cleaner housing inlet snout and align the moulded part line of the air entry hose to the centre lug on the air cleaner housing inlet snout as shown.

When aligned correctly, secure the air entry hose with a 80/100mm hose clamp (item 14).

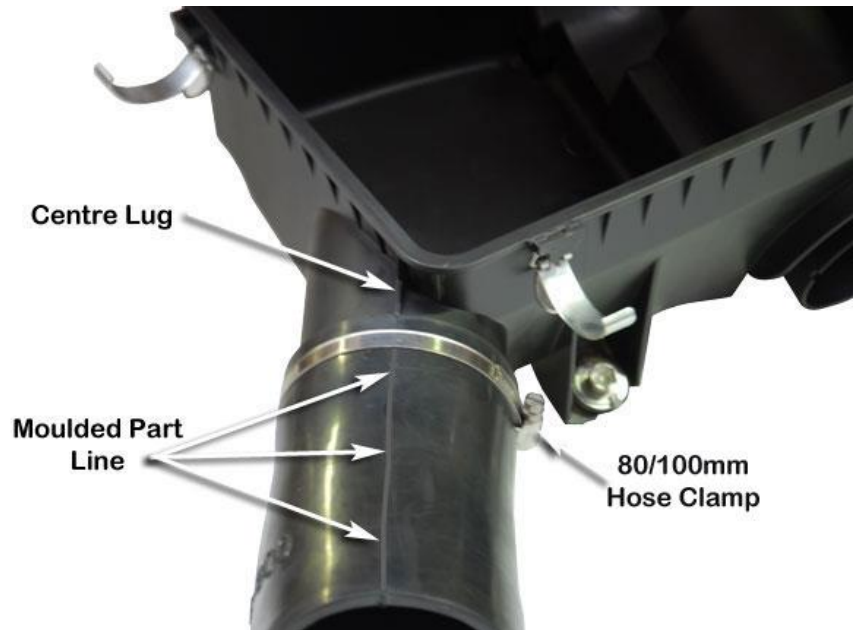

15

Loosely install a 80/100mm hose clamp (item 14) onto the air entry hose (item 13) and install the air cleaner base assembly back into position guiding the air entry hose onto the snorkel body outlet snout.

Fasten the air cleaner base with the original mounting hardware.

Orientate and tighten the 80/100mm hose clamp (item 14).

Install the standard air cleaner element, air cleaner lid and any other components removed during the installation process.

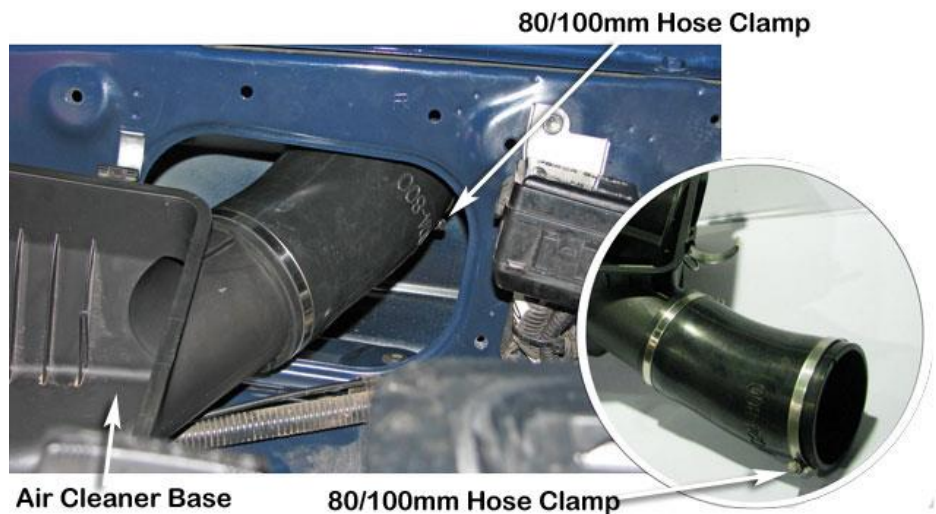



16

Install the black hose clamp (Item 15) loosely to the base of the air ram assembly (Item 2).

Install the air ram assembly onto the snorkel body.

Align the air ram and tighten the black hose clamp (Item 15).



17 N.B. It is the installer's responsibility to ensure that all connections are watertight.