



4X4 ENGINEERING

SS984HF

SAFARI V-SPEC SNORKEL
Ford Everest 1 (All Models)
3.2L TDCi Diesel (P5AT Engine)



24/10/2016

Parts List

ITEM	PART NO.	DESCRIPTION	QTY
1	680-133-300	BODY - SNORKEL (SS982HF)	1
2	000-135-800	3 1/2" AIR RAM ASSEMBLY	1
3	680-032-300	BRACKET - UPPER MOUNTING	1
4	000-002-100	BOLT - HEX - 6mm x 1.0 x 14mm (SEMS)	2
5	000-951	SCREW - S/T - 4.2mm x 13mm - S/S	5
6	000-960	INSERT - PLASTIC	3
7	000-110	STUD - 8mm x 1.25 x 25mm - S/S	6
8	000-311-300	WASHER - BODY - 8mm x 30mm - S/S	6
9	000-205-300	NUT - NYLOC - 8mm x 1.25mm - S/S	6
10	680-024-400	HOSE - AIR ENTRY	1
11	680-025-400	PLATE - HOSE SUPPORT	1
12	000-094-300	BOLT - B/H CAP SCREW 4mm x 0.7mm x 20mm - S/S	6
13	000-096-300	BOLT - B/H CAP SCREW 4mm x 0.7mm x 30mm - S/S	1
14	000-300-350	WASHER - BODY 4mm x 11mm - S/S	7
15	000-223-300	NUT - NYLOC - 4mm x 0.7mm - S/S	7
16	680-217-000	TEMPLATE - AIR CLEANER (UPPER)	1
17	680-217-200	TEMPLATE - AIR CLEANER (LOWER)	1
18	680-959-000	PLUG - AIR INLET BLANK-OFF	1
19	000-910	CLAMP - HOSE - 90/110mm	1
20	000-914/B	CLAMP - HOSE - SIZE 56 (BLACK)	1
21	680-017-400	TEMPLATE - GUARD PANEL (SS984HF)	1

Installation Guide

Fitment to:

- Right Hand Side

Fitting Time:

- 180min

Special Tools:

- 108mm Hole Saw
- Step Drill
- Files
- Drill Bits 4.0mm & 4.5mm
- Loctite 243 (thread lock)
- Touch-up paint
- Sikaflex 227 Adhesive Sealant
- Masking Tape

Prior to commencing the installation, it is the installer's responsibility to verify that all components and particularly the template (Item 21) are correct.

1

Remove and discard the Air intake duct, refit bolts.

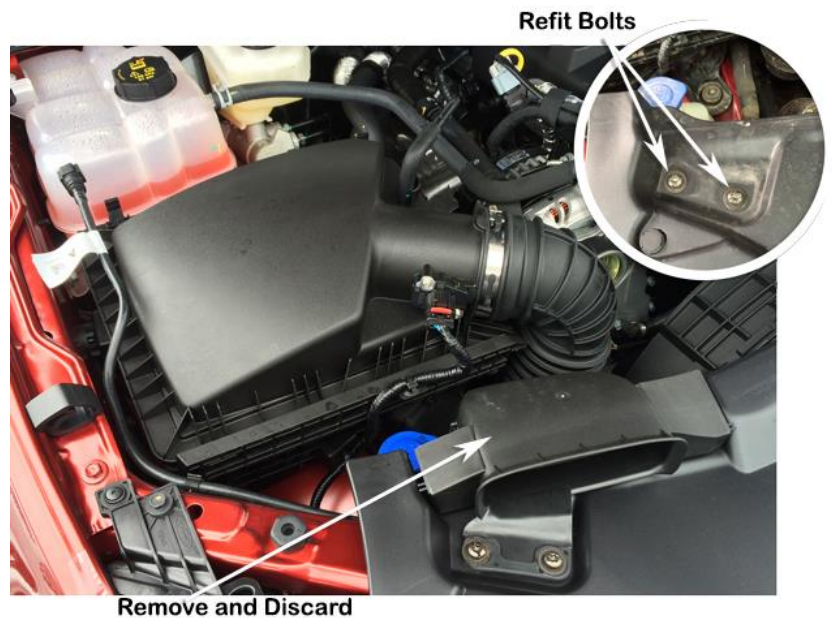

2

Remove the following in accordance with the factory service manual:

- RHS Mud Flap
- RHS Guard Liner
- RHS Guard Insulator
- Air Cleaner Assembly

3

Remove and discard the plug from the inner guard panel.

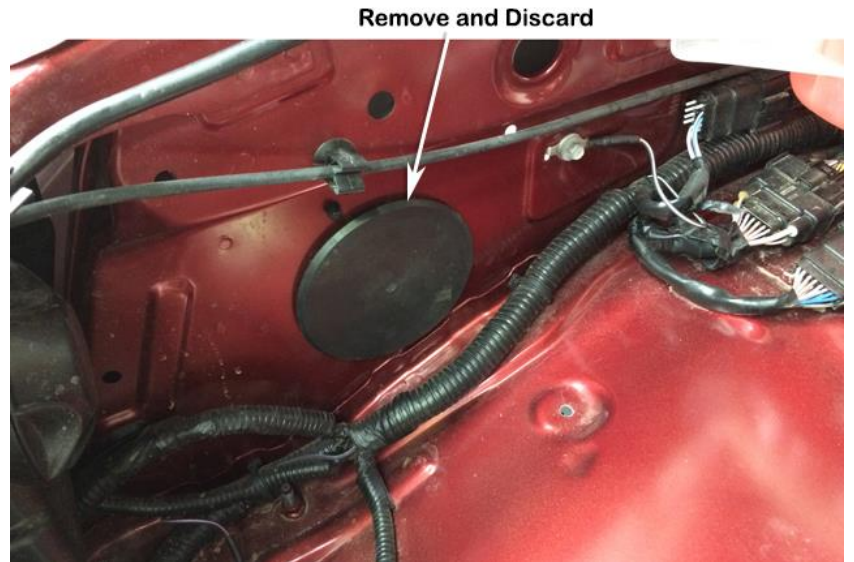

4

Remove and discard the two perforated sections of the guard panel template (item 21) as shown.

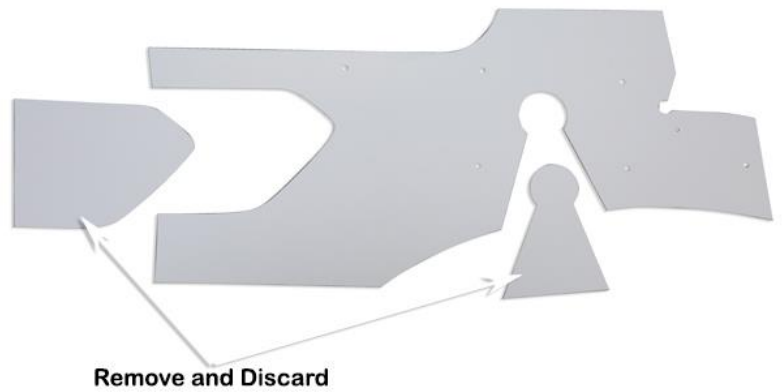

5

Align the guard panel template (Item 21) with the upper and rear edges of the RHS guard panel as shown.

Tape the template to the guard panel with masking tape.

Mark all hole positions with a felt tip pen.

Remove the template.

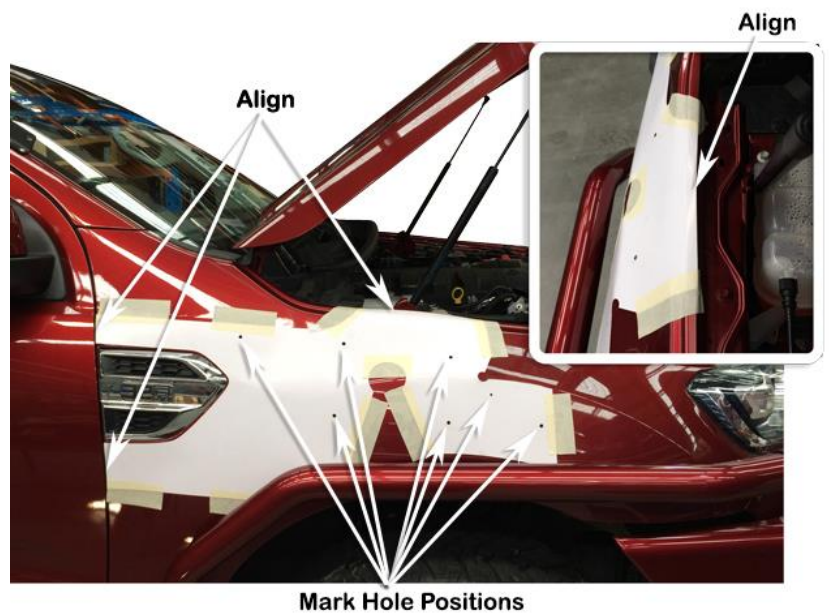

6

Drill a pilot hole for each of the marked hole positions.

Use a 108mm diameter hole saw to drill the snorkel body outlet hole position.

Use a step drill to drill the six mounting holes to 16mm diameter.

Deburr and paint all holes.

Hint: Tape around the guard panel grille to prevent any swarf or metal filings becoming trapped.

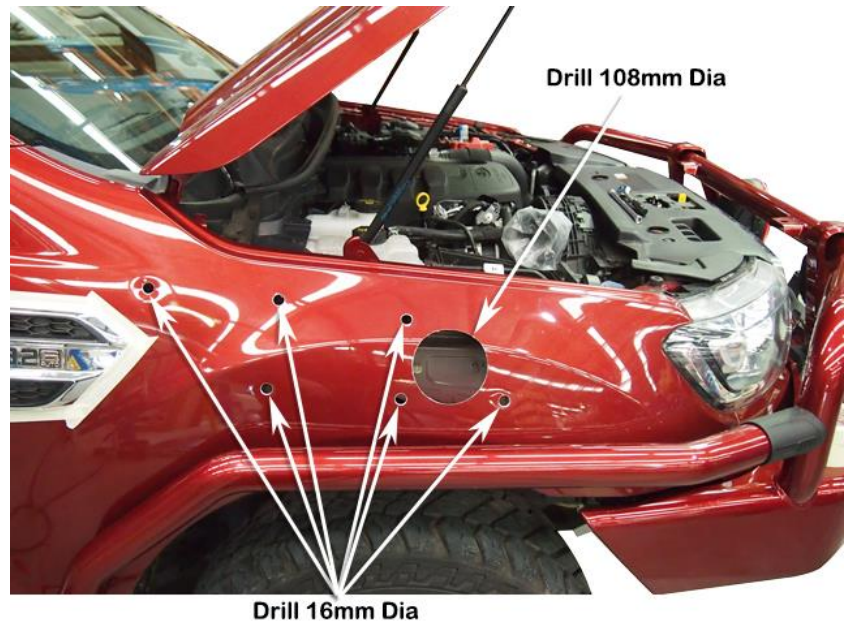

7

Install the upper mounting bracket (Item 3) to the snorkel body (Item 1) with hex bolts (Item 4).

Apply Loctite 243 to each of the stainless steel mounting studs (Item 7) and install the studs finger tight into the snorkel body (Item 1) mounting inserts as shown.

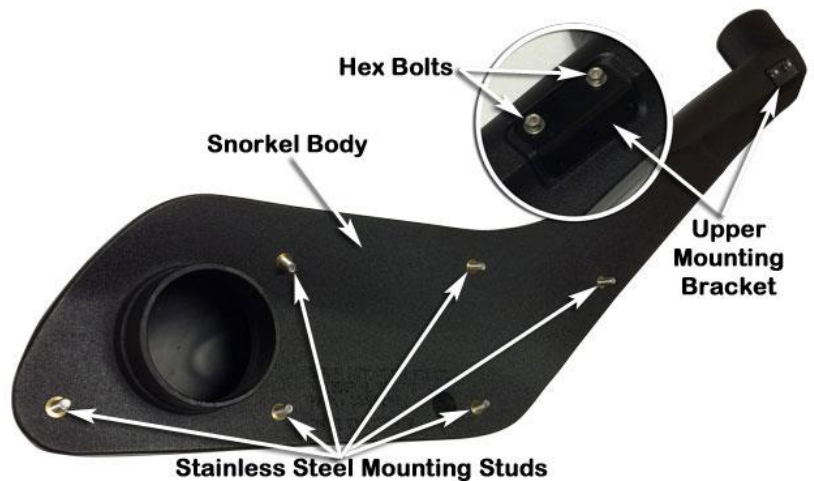

8

Place a strip of masking tape along the A-pillar panel.

Carefully install the snorkel body (Item 1) to the guard panel.

With the snorkel body correctly positioned, mark the outline of the upper mounting bracket (Item 3) onto the masking tape.



Remove the snorkel body (Item 1) from the vehicle and remove the upper mounting bracket (Item 3) from the snorkel body.

Position the upper mounting bracket (Item 3) onto the A-pillar and align the bracket with the marked bracket outline. Mark the three mounting hole positions with a felt tip pen.



Drill a pilot hole at each of the three marked hole positions. Drill each hole position to 8mm diameter with a step drill or 8mm drill bit.

Deburr and paint holes to prevent rust.

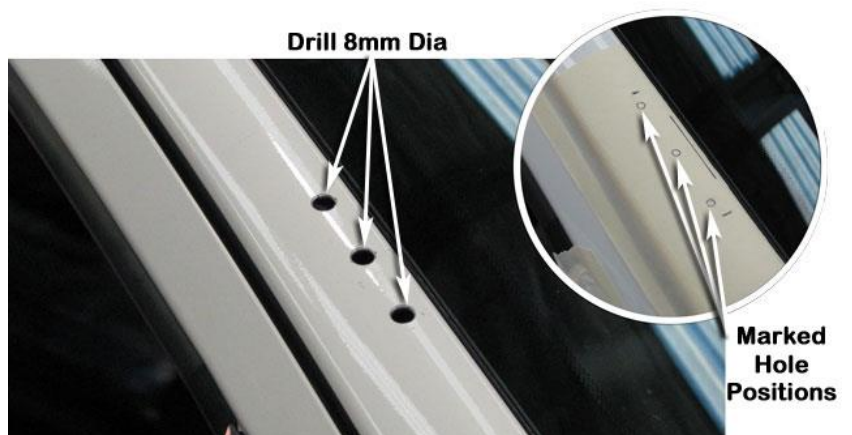

Install the plastic inserts (Item 6) into the 8mm diameter holes in the A-pillar.

Secure the upper mounting bracket (Item 3) to the A-pillar with three self-tapping screws (Item 5).

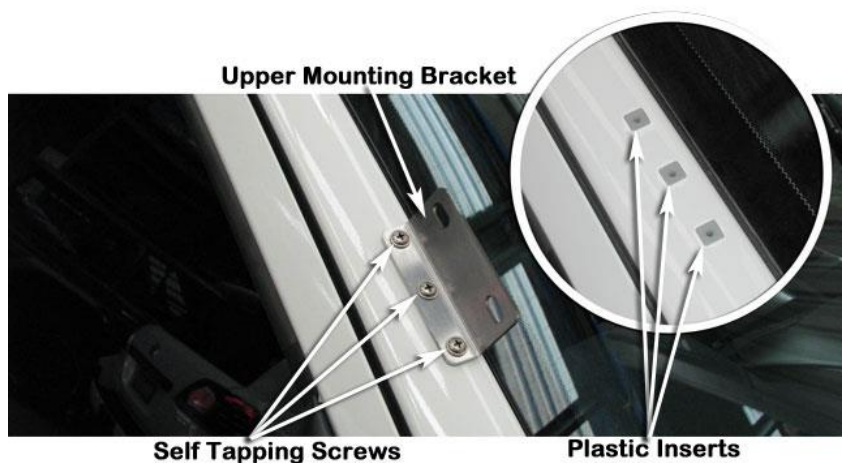

Neatly apply masking tape to the right hand side of the air cleaner base.

Align and tape the upper air cleaner template (item 16) to the air cleaner base shoulders as shown.

Mark all hole positions and the cut out with a felt tip pen (fine point), remove the template.

Align and tape the lower air cleaner template (item 17) to the air cleaner base shoulders as shown.

Mark all hole positions and the cut out with a felt tip pen (fine point), remove the template.

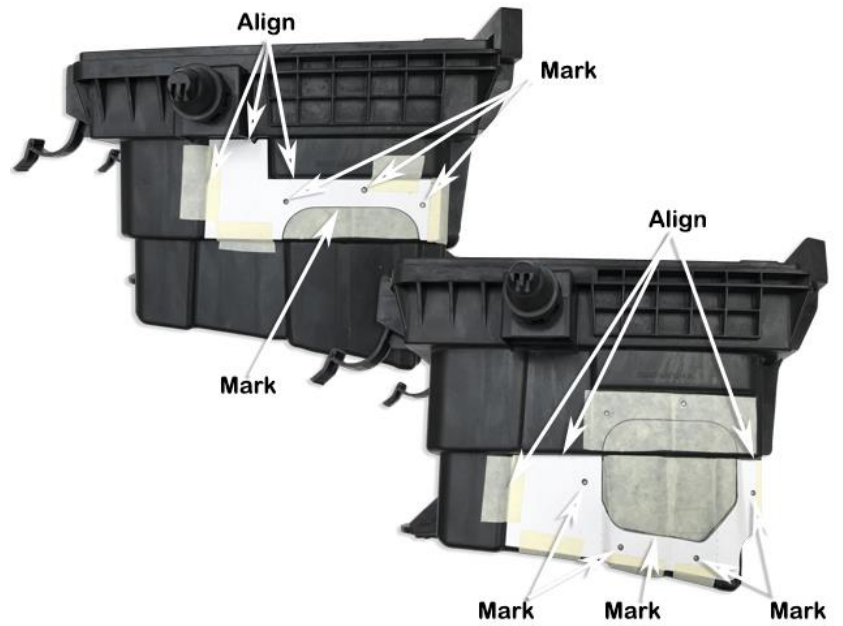

Drill a pilot hole for each of the seven marked hole positions, drill each hole position to 4.5mm diameter with a 4.5mm drill bit.

Using the body saw cut the new air cleaner inlet hole as marked.

De-burr all seven holes and the new air inlet hole.

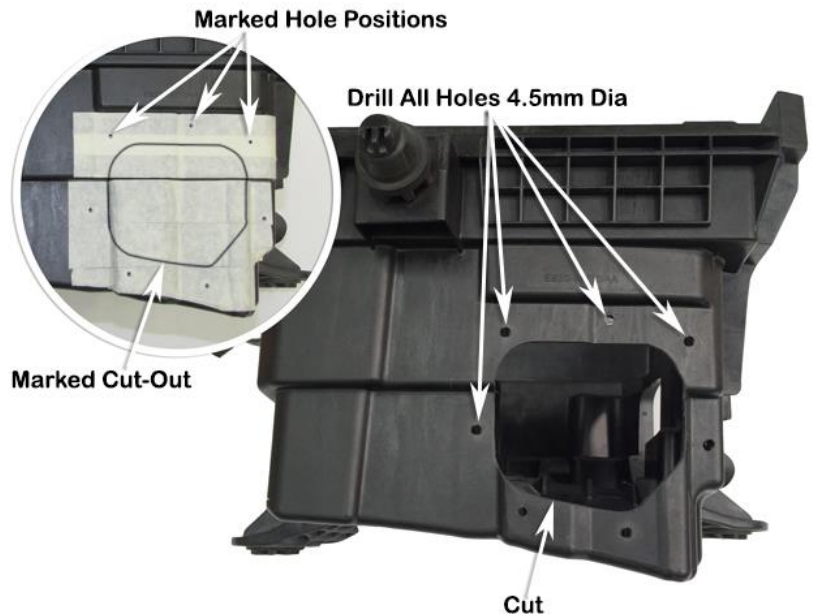

Install the hose support plate (item 11) onto the air entry hose (item 10) as shown.

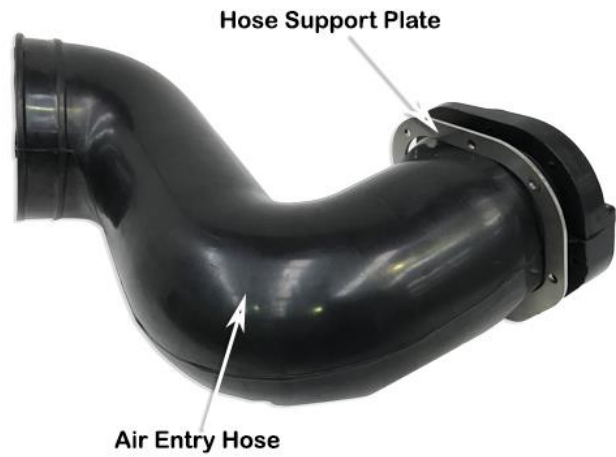

Trial fit the hose onto the air cleaner base, check the new air inlet hole is the correct size.

If necessary, enlarge the size of the hole to suit the air entry hose.

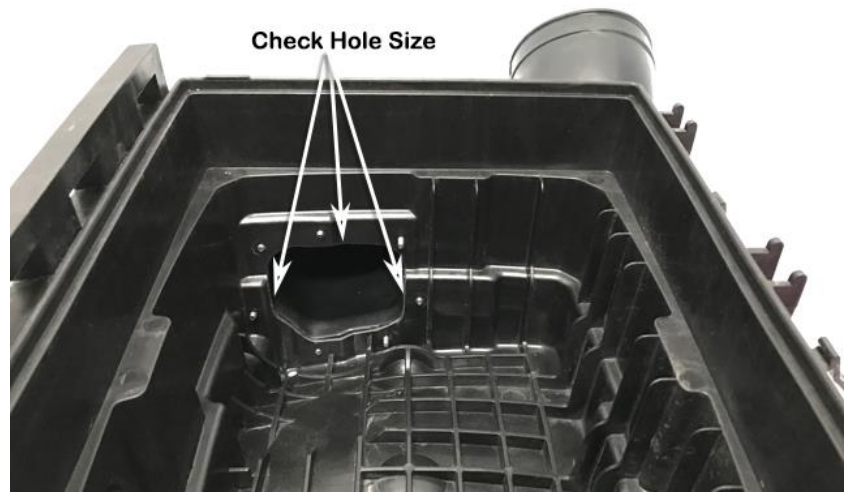

Measure and mark two hole positions 5.0mm in from the end of the air cleaner inlet snout as shown.

Drilled the two marked hole positions with a 4.0mm drill bit.



Apply Sikaflex adhesive sealant to the air cleaner inlet and blank-off plug (item 18), install the blank-off plug into the air cleaner inlet hole and secure with two self-taping screws (item 5).

Clean-up any excess sealant to ensure a neat finish.

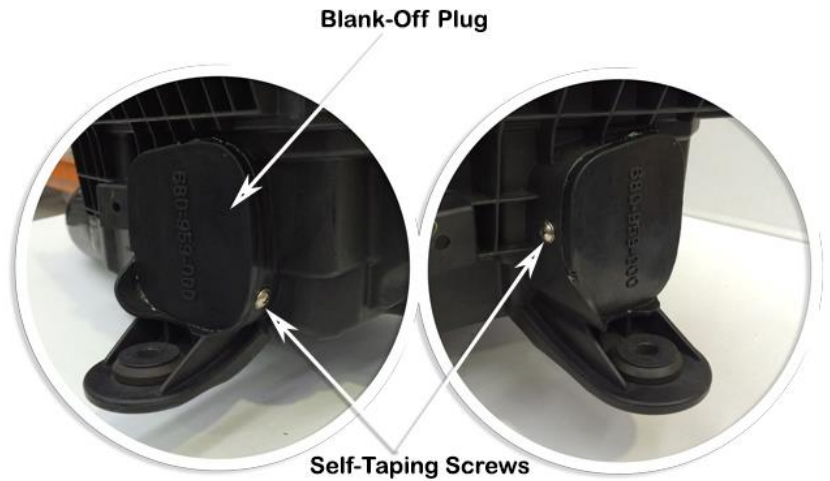

Apply Sikaflex adhesive sealant to the air entry hose flange, install the six M4 x 20mm B/H Cap Screws (item 12) and one M4 x 30mm B/H Cap Screw (item 13) through the support plate (item 11) and air entry hose (item 10).

Install the air entry hose onto the air cleaner base, fasten the air entry hose to the base with M4 body washers (item 14) and M4 nyloc nuts (item 15) as shown.

Do not overtighten the nuts.

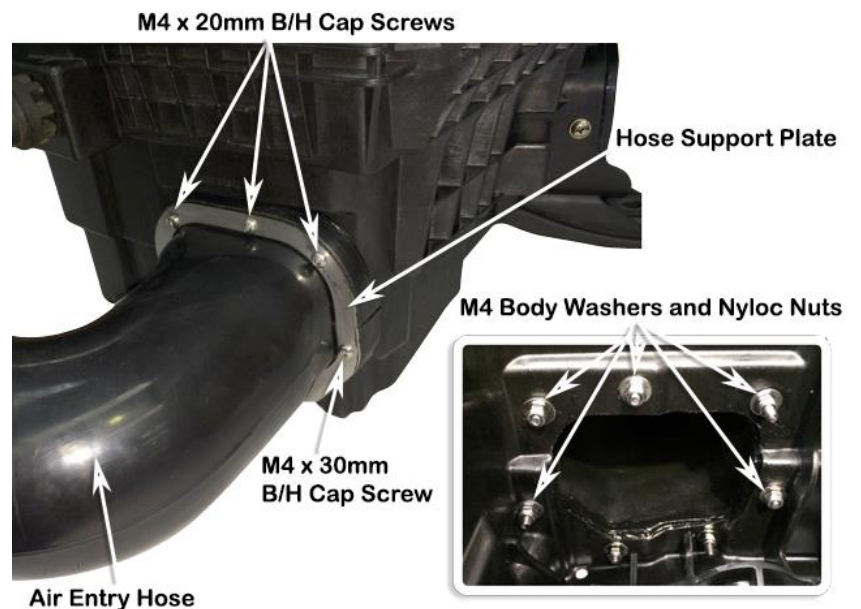

INSTALLER OPTION :

The air cleaner housing base contains a drain hole as shown. The drain hole can permit water to enter the air intake.

Safari advises that the drain hole should be sealed to ensure a watertight installation.



20

The end of the air entry hose (item 10) must be squashed inwards and taped in a couple of places as shown.

Spray the outside of the air entry hose (item 10) with CRC or a similar lubricant.

Install the air cleaner base assembly back into the vehicle, guiding the air entry hose through the hole inner guard panel (if necessary apply more lubricant).

With the air entry hose installed through the hole in the inner guard panel, remove the tape.

Correctly position the air cleaner base and fasten with the standard mounting bolts.

Squash and Tape Air Entry Hose



21

Loosely install the 90/110mm hose clamp (Item 19) onto the air entry hose (item 10).

90/110mm Hose Clamp



22

Carefully install the snorkel body (Item 1) to the guard panel, guiding the snorkel body outlet snout into the air entry hose (item 10), align the snorkel body to guard panel and upper mounting bracket.

When correctly aligned, fasten the snorkel body to the guard panel with body washers (Item 8) and nyloc nuts (Item 9).

Fasten the snorkel body to the upper mounting bracket with hex bolts (Item 4).



23

Align the air entry hose onto the snorkel body outlet snout (*Ensure the air entry hose is installed hard up against the shoulder of the snorkel body outlet, check that the air entry hose has adequate clearance to the standard bracket as shown*), correctly position 90/110mm hose clamp and tighten.

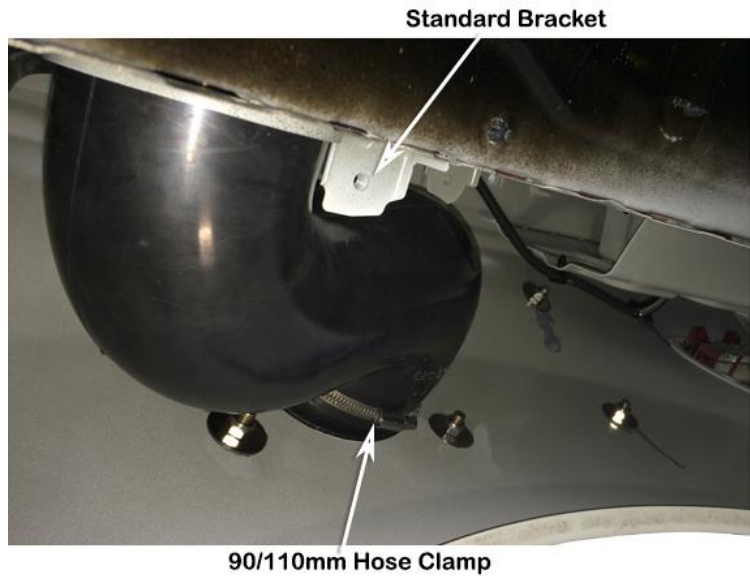

24

Install the black hose clamp (Item 20) loosely over the base of the air ram assembly (Item 2).

Install the air ram assembly onto the snorkel body.

Align the air ram assembly and tighten the black hose clamp (Item 20).



25

Install the RHS guard insulator, guard liner, mud flap, air cleaner element, air cleaner lid, reconnect sensor wiring and any other items that may have been removed during the snorkel installation process.

26

N.B: It is the installer's responsibility to ensure that all connections are water tight.