

THE POWER OF

**REDARC**®

# Smart Battery Monitor

BSEN500

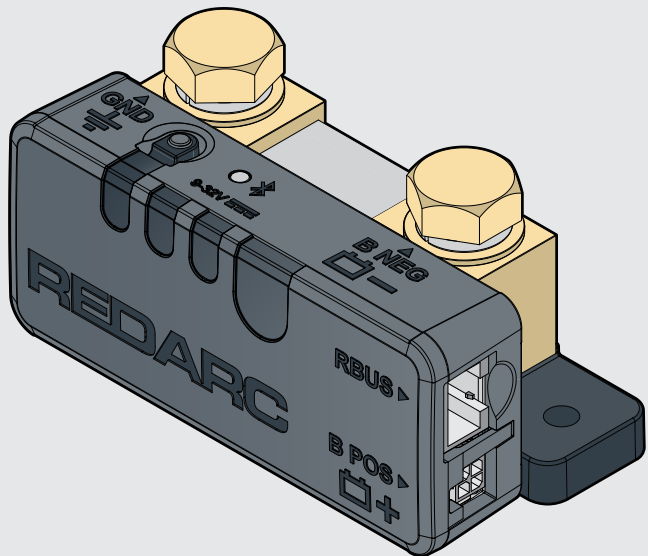

# CONTENTS

<b>WARNINGS &amp; SAFETY INSTRUCTIONS</b> .....	<b>3</b>
<b>PRODUCT OVERVIEW</b> .....	<b>4</b>
Kit Contents .....	4
Wiring Diagram — Standalone Install .....	5
Wiring Diagram — R-Bus Install .....	5
<b>SYSTEM PLANNING</b> .....	<b>6</b>
<b>INSTALLATION — MOUNTING</b> .....	<b>8</b>
Mounting Requirements .....	8
Mounting Clearances .....	9
Mounting Instructions .....	10
<b>INSTALLATION — WIRING</b> .....	<b>11</b>
Lug Assembly .....	11
Ground (GND) Cable Connection .....	12
Battery Negative (BNEG) Cable Connection .....	14
R-Bus Cable Connection .....	15
Battery Sense Lead Connection .....	16
Strain-Relief and Cable Management .....	16
Care and Maintenance .....	17
<b>SYSTEM CONFIGURATION</b> .....	<b>18</b>
Get the RedVision® Configurator App .....	19
Edit a Configuration .....	20
<b>OPERATION</b> .....	<b>21</b>
Get the RedVision App .....	21
<b>TROUBLESHOOTING</b> .....	<b>22</b>
Faults .....	22
<b>TECHNICAL SPECIFICATIONS</b> .....	<b>24</b>
<b>WARRANTY</b> .....	<b>27</b>



# WARNINGS & SAFETY INSTRUCTIONS

**SAVE THESE INSTRUCTIONS** — This manual contains important safety instructions. Do not operate the system unless you have read and understood this manual. REDARC recommends that the products referenced in this manual be installed by a suitably qualified person.

**Disclaimer:** REDARC accepts no liability for any injury, loss or property damage which may occur from the improper or unsafe installation or use of its products.

## SAFETY MESSAGE CONVENTIONS

Safety messages in this manual include a signal word to indicate the level of the hazard as follows:

**⚠ WARNING:** Indicates a potentially hazardous situation which could result in death or serious injury to the operator or to bystanders.

**⚠ CAUTION:** Indicates a potentially hazardous situation which may result in moderate or minor injury to the operator or to bystanders.

**NOTICE:** Indicates a situation that may cause equipment damage.

### ⚠ WARNING

- 1. RISK OF EXPLOSIVE GASES:** Working in the vicinity of a Lead-Acid battery is dangerous. Batteries generate explosive gases during normal operation. For this reason, it is of utmost importance that you follow the instructions when installing and using the Battery Monitor.
2. Keep clear of naked flame, sparks and other sources of ignition. This may cause the battery to explode.

### ⚠ CAUTION

1. Do NOT alter or disassemble the Battery Monitor under any circumstances. All faulty units must be returned to REDARC for repair. Incorrect handling or reassembly may result in a risk of electric shock or fire and may void the unit warranty.
2. The Battery Monitor should not be used by persons (including children) with reduced physical, sensory or mental capabilities, or lack of experience and knowledge, unless they are supervised or have been instructed on how to use the appliance by a person responsible for their safety. Children should be supervised to ensure that they do not play with the Battery Monitor.
3. Only use the Battery Monitor with Standard Automotive Lead Acid, Calcium Content, Gel, AGM, SLI, Deep Cycle or Lithium Iron Phosphate type batteries.
4. Cable sizes are specified by various codes and standards which depend on the type of vehicle the battery is installed in. Selecting the wrong cable size could result in harm to the installer or user and/or damage to the Battery Monitor or other equipment installed in the system. The installer is responsible for ensuring that the correct cable sizes are used when installing this Battery Monitor.

5. If an undersized Battery Negative cable is used, frequent device over temperature faults may occur.
6. Wiring must be installed in protected areas away from heat sources and sharp objects. Cables must not be routed over or through moving parts of the vehicle. Additional protection such as conduit may be required, especially if routing cables through the engine bay.

**PERSONAL SAFETY PRECAUTIONS:** To assist with the safe operation and use of the Battery Monitor when connected to the battery:

- a. **HOT SURFACE:** High amperage loads connected to the Battery Monitor can cause the terminal/metal components to become extremely hot. To avoid burns, do not touch the hot parts without suitable personal protective equipment.
- b. Wear complete eye protection and clothing protection. Avoid touching eyes while working near a battery.
- c. If battery acid contacts your skin or clothing, remove the affected clothing and wash the affected area of your skin immediately with soap and water. If battery acid enters your eye, immediately flood the eye with running cold water for at least 10 minutes and seek medical assistance immediately.



### NOTICE

- Keep the Battery Monitor away from major heat sources, high voltages, and avoid exposure to sunlight for long periods of time.
- DO NOT install the Battery Monitor in the engine bay, this Product is not designed to operate in engine bay environments.
- The installer is responsible for applying the correct torque to the Terminal Bolts. Over-torquing bolts may damage the terminals.
- Do not bottom-out thread when fastening Terminal Bolts into the terminal, this may cause a poor electrical connection (see '[Correct Lug Fitment](#)' (page 14)).
- Do not fit the Battery Sense Lead between the auxiliary battery and lugs carrying high currents.

# PRODUCT OVERVIEW

The Battery Monitor provides critical system information including battery voltage, current, State of Charge (SoC) and temperature information of the connected battery via the RedVision® App.

The Battery Monitor can be combined with REDARC R-Bus compatible products, including the Manager with the RedVision® Display.

The Battery Monitor can also be used independently to monitor and provide information of the connected battery via the RedVision® App.



**Get the Free Configurator App**

**Configure** the settings of your Battery Monitor using your smartphone via Bluetooth®.



**Get the Free RedVision® App**

**Monitor and control** your RedVision® System using your smartphone via Bluetooth®.

The RedVision® App and the Configurator App and their interactions with the Battery Monitor have not been tested on all smartphone models. Visit the application pages within your App store to view compatibility details.

# KIT CONTENTS

## Smart Battery Monitor Unit

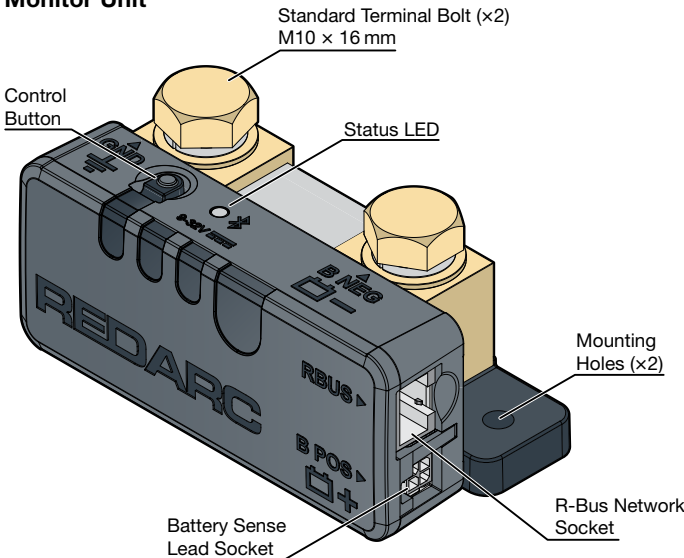

**Alternative Terminal Bolt**  
M10 x 20 mm

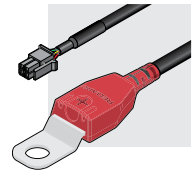

**Battery Sense Lead**  
1 m (3.3')

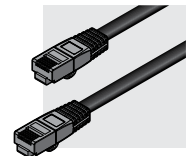

**R-Bus (RJ45) Cable**  
2 m (6.6')

## WIRING DIAGRAM – STANDALONE INSTALL

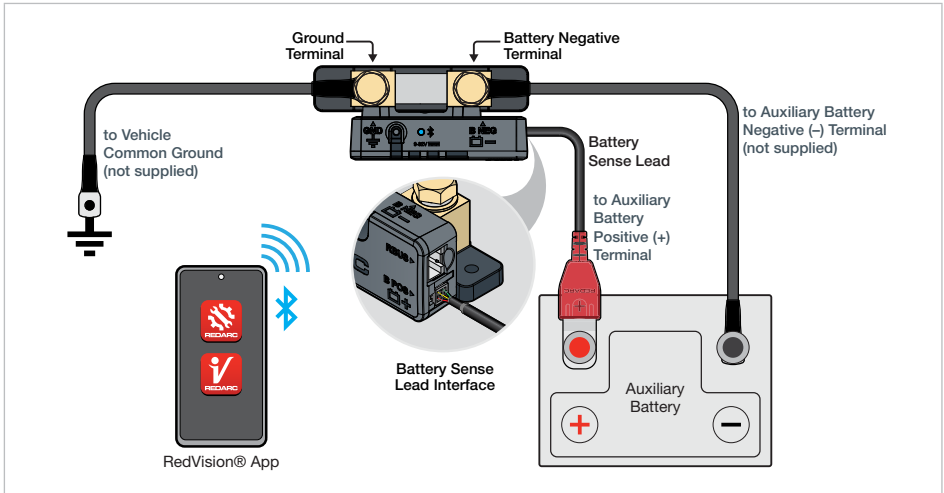

## WIRING DIAGRAM – R-BUS INSTALL

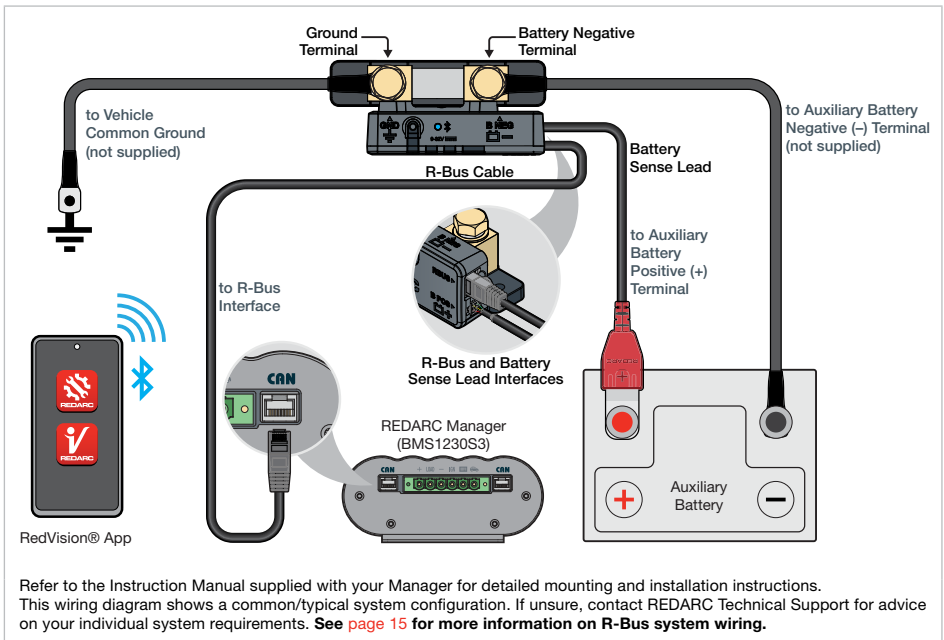

Refer to the Instruction Manual supplied with your Manager for detailed mounting and installation instructions. This wiring diagram shows a common/typical system configuration. If unsure, contact REDARC Technical Support for advice on your individual system requirements. See page 15 for more information on R-Bus system wiring.

# SYSTEM PLANNING

## WHAT YOU WILL NEED

To mount, install and manage cabling of the Battery Monitor, the following common automotive electrical tools and consumables may be required:

- Heatshrink
- Cable cutters
- Cable ties
- Suitable cable lug crimping tool
- Screwdriver/power drill
- P-Clips
- Spanner or Socket to suit M10

## COMMON GROUND

Before planning wiring, consider that the Ground (GND  $\perp$ ) connection and all components in your setup must share a common electrical ground for correct system operation. This is typically achieved by connecting all grounds to the vehicle body.

**NOTE:** Your auxiliary battery's negative connection is made via the Battery Negative (B NEG  $\ominus$ ) terminal on the Battery Monitor.

## LUG REQUIREMENTS

The Ground (GND  $\perp$ ) and Battery Negative (B NEG  $\ominus$ ) terminals have M10 screw threads. Select lugs with a 10 mm (7/16") stud hole and a cable barrel that suits the required cable gauge.

The Ground (GND  $\perp$ ) terminal is capable of connecting multiple loads, for important lug requirements and instructions see '[Connecting multiple loads](#)' (page 12).

**NOTE:** If installing the lugs to the Battery Monitor terminals facing downwards, select a lug where the lug tongue is long enough to cover the shunt surface. This is to ensure the lug cable barrel does not hit against the shunt. See '[Strain-Relief and Cable Management](#)' (page 16) for more information.

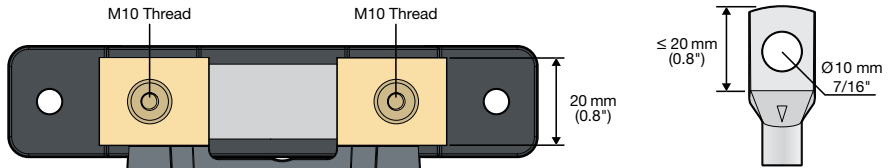

## CABLE REQUIREMENTS

### ⚠ CAUTION:

- Cable sizes are specified by various codes and standards which depend on the type of vehicle the battery is installed in. Selecting the wrong cable size could result in harm to the installer or user and /or damage the Battery Monitor or other equipment installed in the system. The installer is responsible for ensuring that the correct cable sizes are used when installing the Battery Monitor.
- If an undersized Battery Negative cable is used, frequent device over temperature faults may occur.
- Wiring must be installed in protected areas away from heat sources and sharp objects. Cables must not be routed over or through moving parts of the vehicle. Additional protection such as conduit may be required, especially if routing cables through the engine bay.

Appropriate cables are required for the Ground (GND  $\perp$ ) and Battery Negative (BNEG  $\ominus$ ) terminals.

### BATTERY NEGATIVE CABLE

The Battery Negative cable should be no longer than 1 m (3'3") to minimise the voltage drop between the Battery Monitor and auxiliary battery. Refer to the table below to determine a suitable cable gauge for this connection based on the current your system setup has.

**IMPORTANT:** The following table should be used as a reference only, considerations when selecting an appropriate cable for your installation include:

- Cable length
- Peak current draw
- Time spent at high current
- Environment ambient temperature

System Current	100 A	200 A	300 A	400 A	500 A
Maximum Cable Length	1 m (3'3")				
Recommended Cable Cross Section	35 mm <sup>2</sup>	70 mm <sup>2</sup>	95 mm <sup>2</sup>	120 mm <sup>2</sup>	150 mm <sup>2</sup>
Closest Equivalent AWG/BAE/B&S	2	3/0	4/0	250 kcmil	300 kcmil

# INSTALLATION – MOUNTING

## MOUNTING REQUIREMENTS

**NOTICE:** DO NOT install the Battery Monitor in the engine bay, this Product is not designed to operate in engine bay environments.

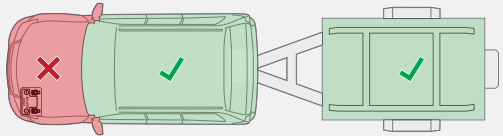

- The Battery Monitor is designed for installation within the vehicles cabin or in a similarly protected environment such as in a ute canopy, caravan or battery box.
- Mount in a location that is dry and is not prone to high humidity. Liquid or vapour entering the Battery Monitor can cause irreparable damage.
- Mount in a location that will avoid using excessive cable length.
- Test that the Battery Sense Lead will comfortably reach between the Battery Monitor and auxiliary battery before installation (1 m (3'3") of cable length).
- Test that the R-Bus cable will comfortably reach between the Battery Monitor and the R-Bus input on a compatible REDARC product before installation (2 m (6'6") of cable length).
- DO NOT mount with the RBUS and B POS (  + ) sockets facing upwards, to prevent condensation/liquids running into the Battery Monitor. The Battery Monitor can be mounted in any other orientation.
- Mount the Battery Monitor permanently to a fixed surface that has adequate strength to support it when all connections and wiring are in-place. DO NOT mount on any moveable parts.
- The mounting surface must be flat and safe to drill through — check the reverse side before drilling.

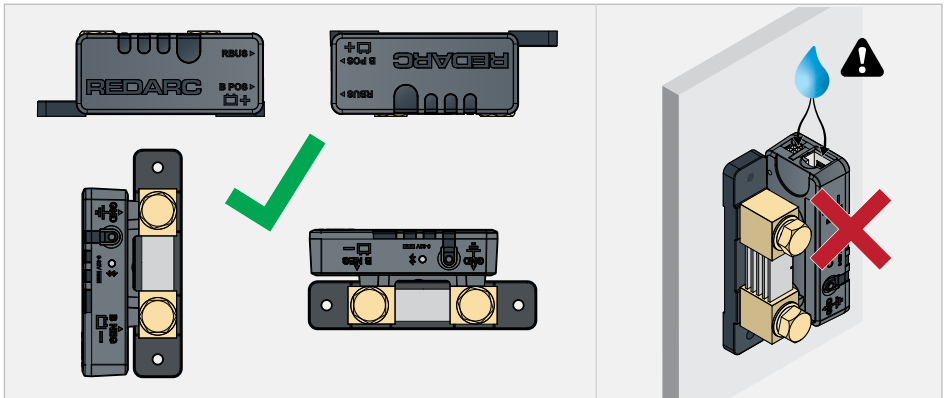



## MOUNTING CLEARANCES

### MOUNTING INTERFERENCES

Ensure the main housing of the Battery Monitor is clear from any protrusions (1 mm (0.04") clearance).

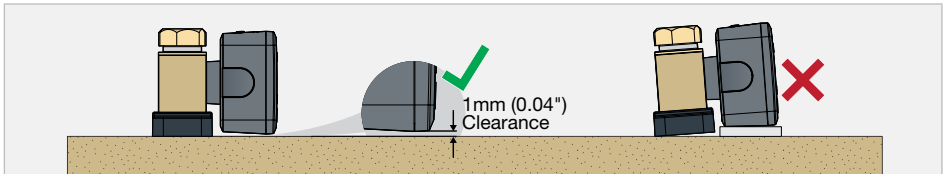

### MOUNTING IN AN ENCLOSED SPACE

**▲ HOT SURFACE:** High amperage loads connected to the Battery Monitor can cause the terminal/metal components to become extremely hot. For this reason, the installer is responsible to **leave at least 30 mm (1.2") of clearance on all sides and above the Battery Monitor** to allow for air-flow.

- Leave at least 100 mm (4") of clearance around the RBUS and B POS (⚡+) sockets to allow for R-Bus cable routing. This clearance also provides room for strain-relief and cable management once wiring is complete. See '[Strain-Relief and Cable Management](#)' (page 16) for more information.
- Mount in a location where the Control Button and Status LED are visible and accessible.
- If installing the Battery Monitor in an enclosed space, make sure there is adequate venting. Two vents should ideally be positioned at the top and bottom of the enclosure for cross-flow of air.

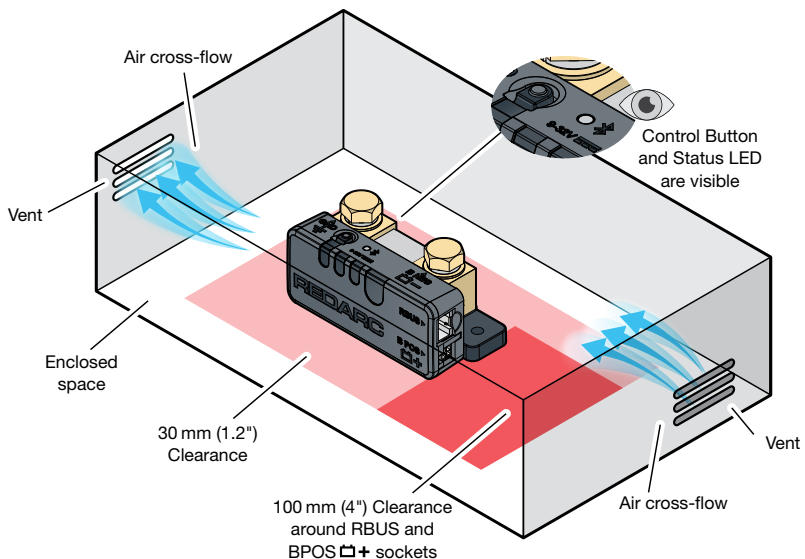

# MOUNTING INSTRUCTIONS

## MOUNTING HARDWARE

When mounting the Battery Monitor, both Mounting Holes must be used.

Ensure the selected fasteners are suitable for the mounting surface and there is clearance-fit through the Mounting Holes on the Battery Monitor.

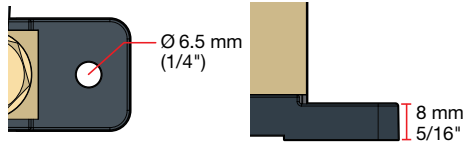

Two fasteners are required for mounting the Battery Monitor. REDARC recommend using M6 (1/4") to M4 (8#) fasteners with washers.

If using countersunk fasteners, apply countersunk washers to avoid damaging the Mounting Holes.

**Do not mount the Battery Monitor using adhesives or adhesive tape.**

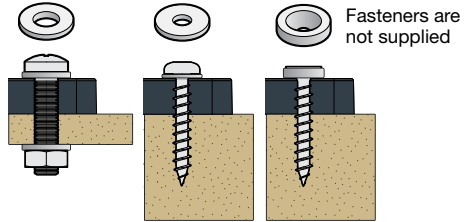

## MOUNTING STEPS

**⚠ WARNING:** Use suitable Personal Protective Equipment (PPE) when operating power tools.



1. Confirm clearances around the Battery Monitor are adequate.
2. If clearance/pilot holes need to be drilled, place the Battery Monitor in its final position and mark the centre of each Mounting Hole.
3. Remove the Battery Monitor and drill the holes.
4. Fasten the Battery Monitor in place, applying a washer in between the fastener and the Mounting Hole.

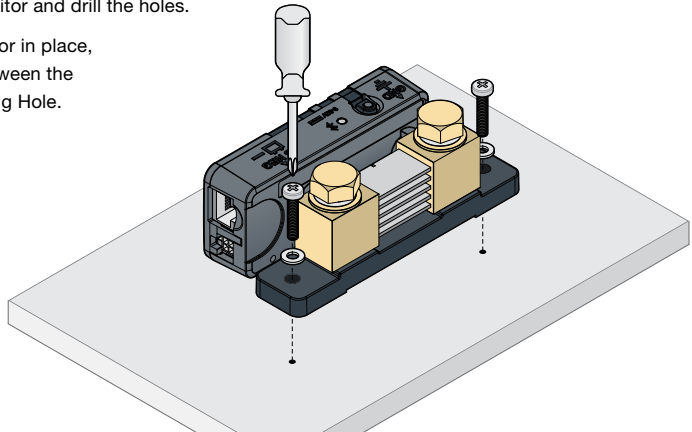

# INSTALLATION – WIRING

**⚠ CAUTION:** Ensure the correct cable and lug sizes is used to suit the application. Selecting the wrong cable and lug size could result in harm to the installer or user and/or damage to the battery or other equipment installed in the system. The installer is responsible for ensuring that the correct cable sizes is used when installing the Battery Monitor.

**NOTICE:**

- The installer is responsible for applying the correct torque to the Terminal Bolts. Over-torquing bolts may damage the terminals.
- Do not bottom-out thread when fastening Terminal Bolts into the terminal, this may cause a poor electrical connection (see 'Correct Lug Fitment' (page 14)).

**IMPORTANT:** Only connect the Battery Sense Lead once ALL other wiring is complete.

## LUG ASSEMBLY

Before making any connections to the Battery Monitor, assemble (or purchase) the Ground and Battery Negative cables with the appropriate size lug and heatshrink as shown below.

REDARC recommends using heatshrink to protect the cable and lug connection from harsh environments, sharp edges and abrasion.

Strip the end of the cable back enough to ensure the insulation does not enter the barrel of the lug when fully inserted.



Slide the heatshrink over the cable.



Insert the stripped wires into the barrel of the lug.



Crimp the lug using the correct crimping tool.



Slide the heatshrink to partially cover the lug, leaving the lug tongue exposed. Leave adequate clearance around the stud hole for the Terminal Bolts.



Shrink the heatshrink.



## GROUND (GND) CABLE CONNECTION

Remove the M10 Bolt and washers from the Ground (GND  $\perp$ ) terminal (1). Then align the lug stud hole with the terminal and fasten using the flat washer, spring washer and bolt (2). Torque to 20 Nm (14.7 ft-lbf).

Connect the Ground cable to a point that forms a common ground with all components in your setup (3). Most commonly, the vehicle electrical system's ground/earth reference is the metal of the vehicle body/chassis.

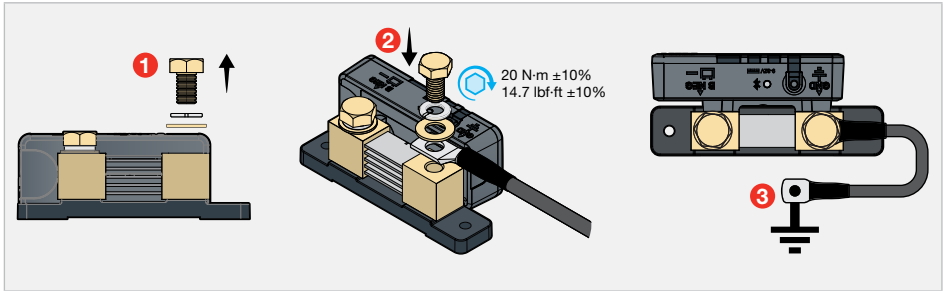

## CONNECTING MULTIPLE LOADS

**⚠ CAUTION:** Do not use the Battery Monitor outside the supplied recommendations. Exceeding the recommendations could damage the Battery Monitor and/or other equipment installed in the system. The installer is responsible for ensuring the correct bolt size and Ground cable size is used.

The Battery Monitor is capable of connecting multiple loads to the Ground (GND  $\perp$ ) terminal. Depending on your system setup, you may need to use the supplied Alternative Terminal Bolt (M10 × 20 mm). Refer to the table to determine if this Bolt is required. The lugs belonging to circuits with the highest currents should be closest to the Battery Monitor terminal.

Bolt Size (supplied)	Combined Thickness of Lug Tongues	
	Minimum	Maximum
Standard M10 × 16 mm	–	4 mm (5/32")
Alternative M10 × 20 mm	4 mm (5/32")	8 mm (5/16")

### Lug thickness for Ground (GND $\perp$ ) Terminal

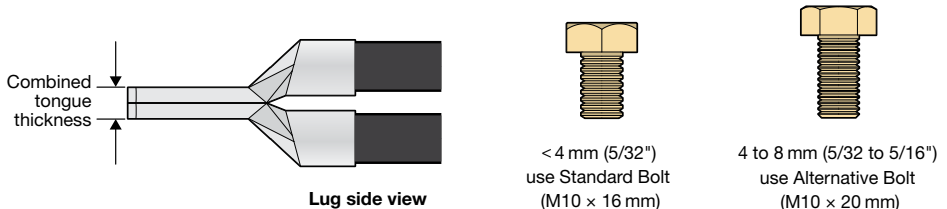

## USING A TERMINAL BLOCK

When connecting multiple loads to the Ground (GND  $\perp$ ) terminal of the Battery Monitor, using a separate terminal block/earth busbar is recommended. Ensure the Ground cable connection to busbar is a sufficient size to suit your application.

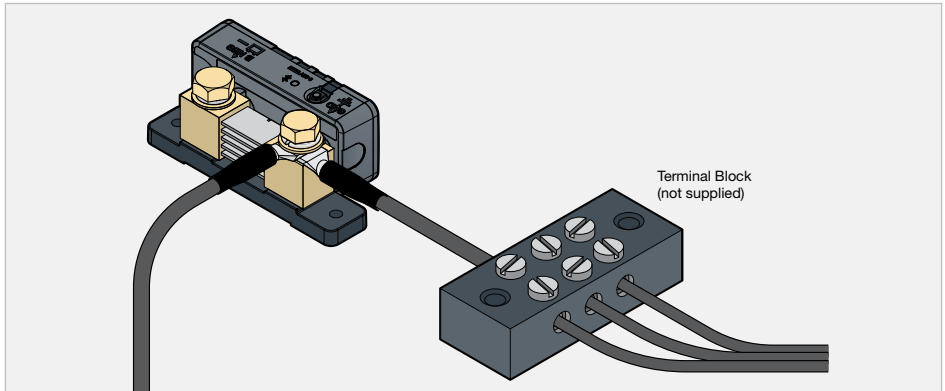

## BATTERY NEGATIVE (B NEG) CABLE CONNECTION

Remove the M10 Bolt and washers from the Battery Negative (B NEG  -) terminal (1). Then align the lug stud hole with the terminal and fasten using the flat washer, spring washer and bolt (2). Torque to 20 Nm (14.7 ft-lbf).

Connect the Battery Negative cable to the auxiliary battery negative (-) terminal using appropriate fasteners (3). **NOTE:** The Battery Negative cable should not exceed 1m (3'3") to minimise voltage drop between the Battery Monitor and auxiliary battery.

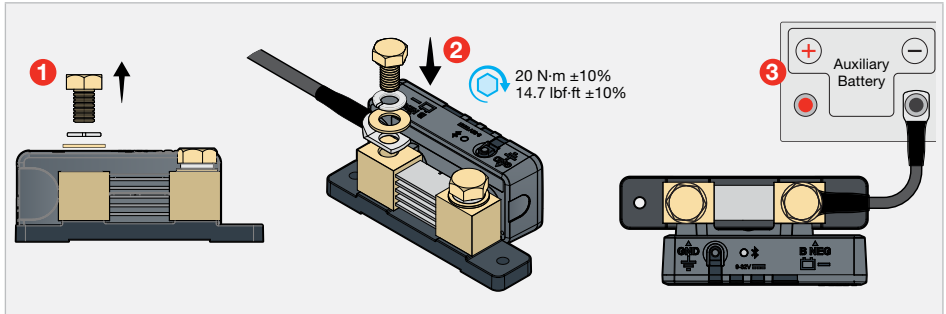

## CORRECT LUG FITMENT

Hold the Ground and Battery Negative cables when torquing to avoid the cables touching the Battery Monitor Housing, this will prevent from potentially damaging the Battery Monitor.

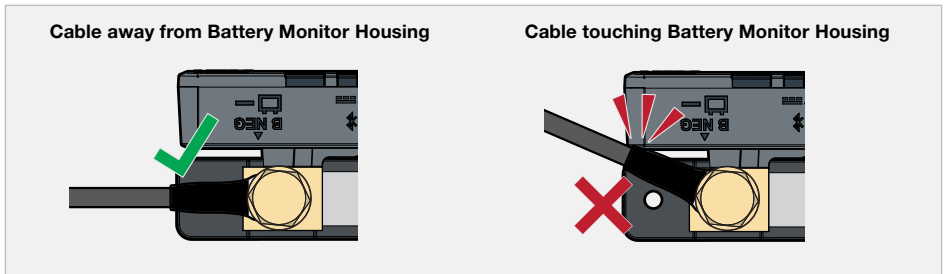

## R-BUS CABLE CONNECTION

### IMPORTANT:

- **The Battery Monitor is not designed to be used alone with the RedVision® Display.**
- **DO NOT** connect computers or IT equipment to the R-Bus socket. This may damage internal components.

### CONNECTING THE BATTERY MONITOR TO THE REDVISION® SYSTEM

The supplied R-Bus cable is used to connect the Battery Monitor to the RedVision® system.

Connect one end of the R-Bus cable to the RBUS socket on the Battery Monitor. Then, connect the other end of the cable to any available R-Bus (CAN) socket on the Manager or other compatible REDARC Products with an R-Bus system.

**NOTE:** Leave a minimum of 100 mm (4") of clearance around the RBUS socket on the Battery Monitor to allow routing of the R-Bus cable.

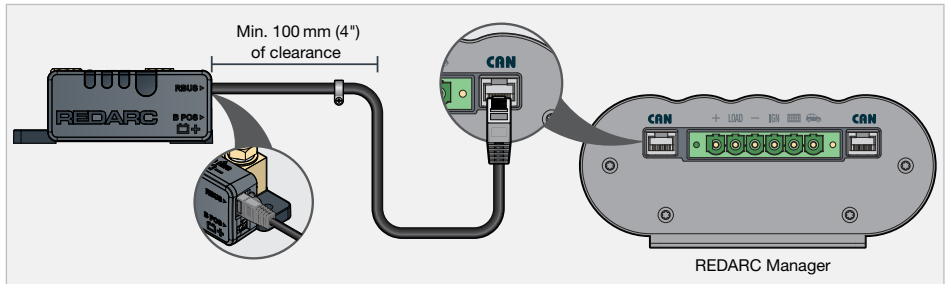

### REDVISION® SYSTEM SETUP EXAMPLE

To incorporate the Battery Monitor into your R-Bus system, connect the devices in a continuous daisy-chain network. Terminating Resistors must be present at each end of the daisy-chain to complete the R-Bus system (supplied with the Manager). **The Battery Monitor has its own built in terminating resistor.** An example is shown below.

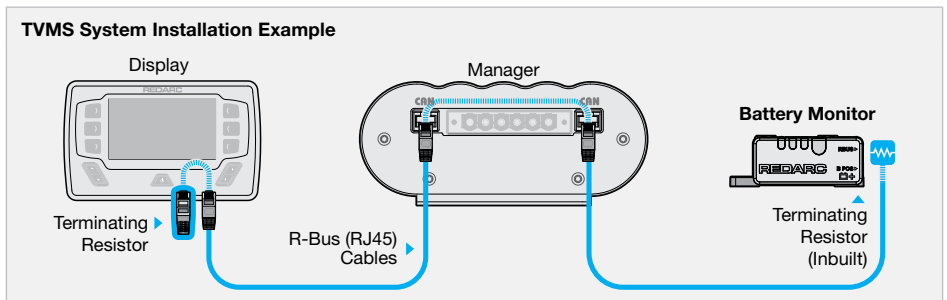

## BATTERY SENSE LEAD CONNECTION

Insert the Battery Sense Connector on the Battery Sense Lead into the B POS  + socket on the Battery Monitor. Then, connect the Battery Sense Lug to the auxiliary battery positive (+) terminal using appropriate fasteners to secure.

**NOTICE:** Do not fit the Battery Sense Lead between the auxiliary battery and lugs carrying high currents.

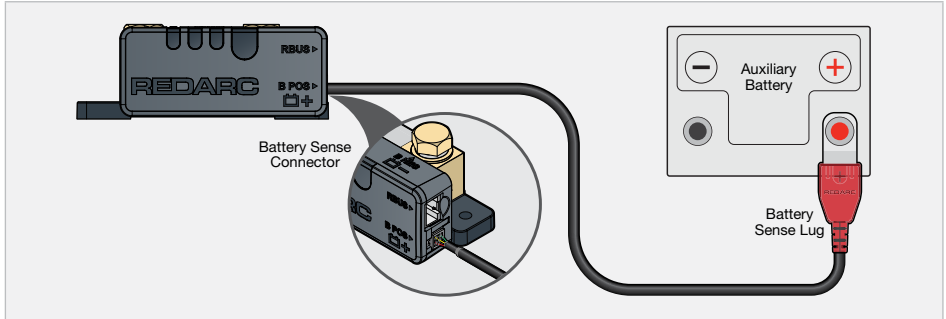

## STRAIN-RELIEF AND CABLE MANAGEMENT

**⚠ CAUTION:** Wiring must be installed in protected areas away from heat sources and sharp objects or over/through parts of the vehicle that move during operation or maintenance. Additional protection such as conduit may be required, especially if routing cables through the engine bay.

**NOTICE:** Do not bottom-out the thread when screwing the bolt into the terminal, this may cause a poor electrical connection.

**IMPORTANT:** Ensure lugs are fastened firmly against the top face of the terminal. Loose lugs will have a bad electrical connection, causing inaccurate readings from the Battery Monitor, and can result in damage to the wiring and Battery Monitor.

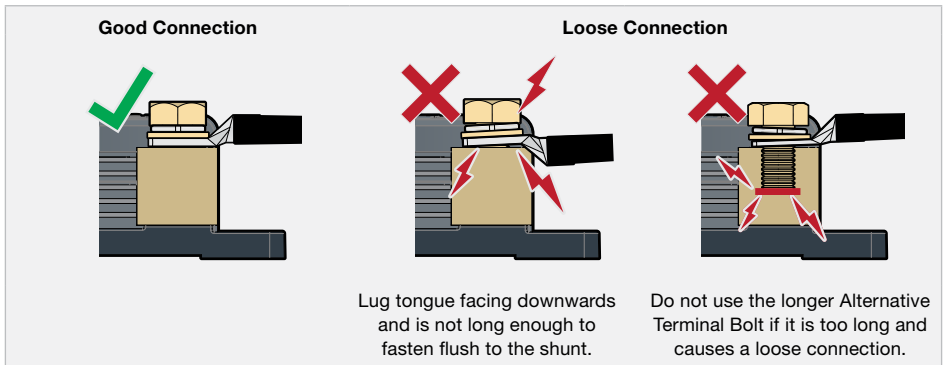



## PROTECT AND SECURE THE CABLES

- Allow strain-relief for cables, ensuring cables are not pulled or stretched tightly. This can cause damage or allow the cables to become loose and affect the performance of the Battery Monitor.
- To avoid connections becoming loose, secure all cables to a fixed point close to the Battery Monitor (ideally within 200 mm (8")). Cable ties, cable clips and P-clips are recommended.
- Flexible conduit can be used to manage and protect bundled cables.

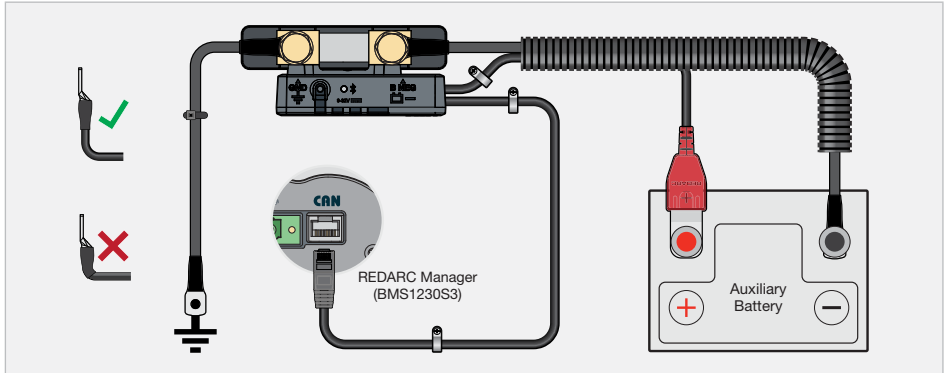

## AVOIDING WATER ENTRY

Ensure that cables are routed with drip loops, this is to prevent moisture from running down the cables into the Battery Monitor.

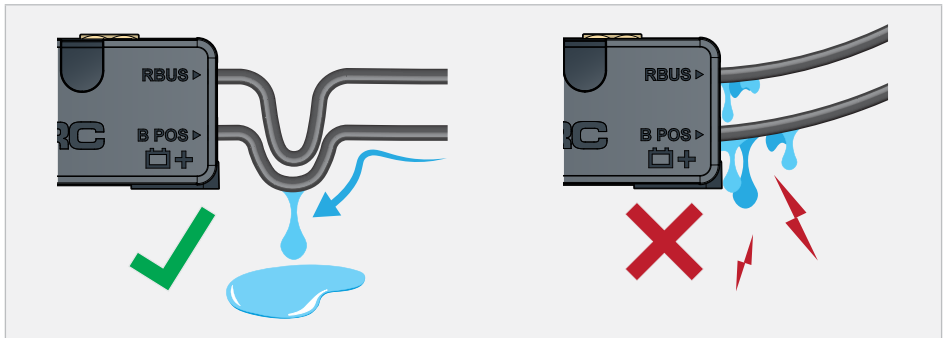

## CARE AND MAINTENANCE

Periodically check that all connections are firm, and all cables are adequately managed. Parts of the system may have moved from repeated vibration, particularly if the vehicle has been travelling on uneven/corrugated road surfaces.

# SYSTEM CONFIGURATION

Once the Battery Monitor installation is complete, it needs to be configured using the RedVision Configurator App. The App defines the behaviours and operation of the Battery Monitor and informs the Battery Monitor of your auxiliary battery's specifications.

If an R-Bus device is incorporated in your system, the RedVision Configurator App needs to be used in order to configure your entire system. Refer to the R-Bus device's Instruction Manual for further information on configuring its system.

## BLUETOOTH PAIRING MODE

When power is first applied to the Battery Monitor, the Status LED will quickly flash White to indicate the Battery Monitor is ON. Directly afterwards, the Status LED will automatically begin to flash Blue, entering into Bluetooth pairing mode.

Bluetooth pairing mode will time out after approximately 90 seconds. Hold the Control Button between 0.5 to 3 seconds to enter back into Bluetooth pairing mode. When in pairing mode the Status LED will flash Blue. Once a smartphone device is paired to the Battery Monitor, the Status LED will stay solid Blue. See '[Troubleshooting](#)' (page 22) for bluetooth pairing instructions.

## FAULT INDICATION

The Status LED will turn solid Red or flash Red/Blue (if Bluetooth is connected) to indicate a fault detection, for more information see '[Troubleshooting](#)' (page 22).

# GET THE REDVISION® CONFIGURATOR APP



## GET THE REDVISION® CONFIGURATOR APP

Download the free REDARC RedVision® Configurator App to Configure the settings of your Battery Monitor using your smartphone via Bluetooth®.



The Configurator App and its interactions with the Battery Monitor have not been tested on all smartphone models. Visit the application pages with your App store to view compatibility details.

## PAIRING THE BATTERY MONITOR TO THE CONFIGURATOR APP

1. Download the RedVision® Configurator App and make sure Bluetooth is enabled on your smartphone.
2. Press the Control Button on the Battery Monitor for 0.5 to 3 seconds, then the Status LED will flash Blue and the Battery Monitor will enter into Bluetooth pairing mode.
3. Open the Configurator App and allow the required permissions if it's the first time using the App. Then, in the **Config System** screen, press the **Read Device** button and select the system that matches the Product Serial Number on the Battery Monitor.
4. Under the Manager heading, tap the **green arrow** (➤) next to your Battery Monitor (check the system matches the Product Serial Number).
5. Configure the Battery Monitor by entering in your auxiliary battery's specifications\* (refer to your battery manufactures specifications). Once completed, tap **Save** (✓).
6. If the Status LED on the Battery Monitor is Off, press the Control Button for 0.5 to 3 seconds to enter back into Bluetooth pairing mode, then, in the Configurator App press **Program** (👉).
7. In the **Config System** screen, re-select the system that matches the Product Serial Number on the Battery Monitor. Do not exit the Configurator App until the success banner appears and the Status LED on the Battery Monitor turns solid Blue. Once this occurs the Bluetooth pairing is complete.

**\*NOTE:** System setups without an R-Bus Interface are not able to configure the Maximum Charge setting.

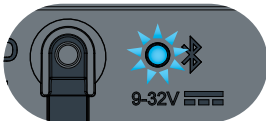



Bluetooth Pairing Mode



Bluetooth Connected

## EDIT A CONFIGURATION

1. Open the RedVision Configurator App.
2. From the list, choose the configuration you want to edit.
3. Edit the configuration as required to suit your setup — remember to tap **Save**  each time you make a change.
4. Once all changes have been made, press **Program** .

## END-USER LOCKOUT

The Battery Monitor allows you to add an Installer PIN (personal identification number) to prevent end-users from changing the configuration of their RedVision® system. This is to avoid safety hazards if the system is reconfigured in an unsafe way by persons who do not fully understand the system requirements.

**IMPORTANT: By adding an Installer PIN, the saved Configuration cannot be edited without entering the correct PIN. DO NOT forget the PIN.**

### ADD AN INSTALLER PIN:

1. Open the RedVision® Configurator App.
2. From the **Config System** screen, select the configuration you want to add an installer PIN to.
3. Tap the **Settings icon** at the top right of the screen, then select **Add Installer PIN** from the pop-up list.
4. Type a 4 to 8 digit PIN into the **New PIN** field, then retype it in the **Confirm New PIN** field. Tap **Add**.
5. The PIN will now have to be entered to make any changes to the locked configuration.

### REMOVE THE INSTALLER PIN:

1. Open the RedVision® Configurator App.
2. From the **Config System** screen, select the configuration you want to remove the Installer PIN from.
3. Tap the **Settings icon** at the top right of the screen then select **Remove Installer PIN** from the pop-up list.
4. Type the PIN into the **Current PIN** field, then tap **Remove**.

# OPERATION

System testing is an important step to confirm the end-user experience of the configured system. Identifying and correcting errors is important before the system is operational and on-the-road.

1. Download and install the RedVision® App.
2. Open the App and check that each connected device appears and functions as intended.
3. To test the system, power up a connected charger and check that the current flow is into the auxiliary battery and the arrow is pointing up and green.

## GET THE REDVISION APP



### GET THE REDVISION® APP

The RedVision® App gives you remote access to Battery Monitor functions and features including battery level monitoring, system and terminal source monitoring.



The RedVision® App and its interactions with the Battery Monitor have not been tested on all smartphone models. Visit the application pages with your App store to view compatibility details.

### PAIRING THE BATTERY MONITOR TO THE REDVISION® APP:

1. Download the RedVision® App and make sure Bluetooth is enabled on your smartphone.
2. Press the Control Button on the Battery Monitor for 0.5 to 3 seconds then the Status LED will flash Blue and the Battery Monitor will enter into Bluetooth pairing mode.
3. Open the RedVision® App and allow the required permissions if it's the first time using the App. Then, tap the **Menu Icon** ☰. Under the devices heading, tap the **Add Icon** (+).
4. Find and select the device that matches the Product Serial Number on your Battery Monitor. Read and agree to the disclaimer.
5. When the Bluetooth pairing request appears, tap **Pair** (first time pairing may take a few minutes).
6. Once the Status LED turns solid Blue, and the system information appears on your smartphone the Bluetooth pairing is complete (first time pairing may take a few minutes).

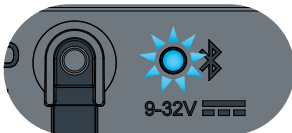

Bluetooth Pairing Mode



Bluetooth Connected

## SUBSEQUENT CONNECTIONS

Once the smartphone has been paired with the Battery Monitor, it will automatically reconnect when the RedVision® App is opened and the Battery Monitor is selected — Tap the **Menu icon** ☰ at the top right, then select the Battery Monitor from the list of devices.

## PAIR MULTIPLE SMARTPHONES

The Battery Monitor can be paired to multiple smartphones; however it can only be monitored/controlled by one smartphone at a time. When the RedVision® App is minimised on one smartphone, the RedVision® App can be opened on another smartphone and will connect automatically if it has previously been paired.

To pair another smartphone, repeat the steps on [page 21](#).

## AUXILIARY BATTERY STATE OF CHARGE ESTIMATE

The Battery Monitor's time-till-full/flat (TTFF) value displayed on the RedVision® App indicates the estimated time until the auxiliary battery is fully charged or completely depleted based on your current charge usage rate. This allows you to manage the auxiliary battery's life and plan your device usage accordingly.

# TROUBLESHOOTING

## FAULTS

Faults are indicated by the Status LED on the Battery Monitor:

- **Flashing Red/Blue** — Fault detected whilst a smartphone is connected to the Battery Monitor via the RedVision® App.
- **Solid Red** — Bluetooth pairing and/or R-Bus device communication Fault detected.

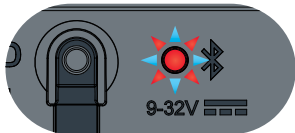

Flashing Red/Blue

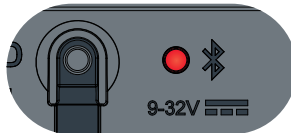

Solid Red

## FLASHING RED/BLUE LED

In the event of the LED flashing Red/Blue refer to the RedVision® App on your smartphone or the RedVision® Display to identify the cause of the Fault.

The Battery Monitor is capable of detecting Faults including out of range temperature and voltage of the auxiliary battery.

## SOLID RED LED

If the Status LED is solid Red, there is a Bluetooth pairing error and/or a connection error in the R-Bus system. In the event of a solid Red LED, the RedVision® App, Configurator App and/or wired R-Bus connected devices will be unable to communicate with the Battery Monitor.

## BLUETOOTH TROUBLESHOOTING

To resolve, complete the following steps, then repeat the Bluetooth pairing instructions on [page 21](#) before directly contacting REDARC Tech Support or your local REDARC Distributor.

1. In the RedVision® App, click the **Menu Icon** ≡ to navigate to the list of devices, locate your Battery Monitor device and delete it.
2. In your smartphone's Bluetooth settings, remove the Battery Monitor from your Bluetooth devices list.
3. Switch off and re-start your smartphone.
4. **Clearing Pairings** — Ensure the Battery Monitor is in Bluetooth pairing mode (Status LED is flashing Blue), then hold the Control Button for 5 seconds or until the Status LED begins to flash rapidly. Once the Status LED stops flashing rapidly, all Bluetooth pairings are cleared from the Battery Monitor.

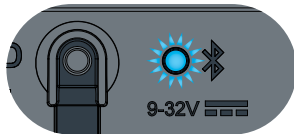

Hold the Control Button  
to Clear Pairings

## DISPLAY TROUBLESHOOTING

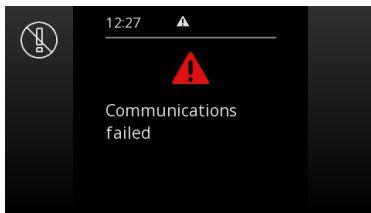

Fault indication  
on the Display.

To resolve installations where a Display is incorporated in your R-Bus system complete the following steps, in order, before directly contacting REDARC Tech Support or your local REDARC Distributor:

1. Check the R-Bus cable to make sure it is securely connected to the correct socket on each R-Bus input in your system.
2. Confirm that terminating resistors are fitted at each end of the R-Bus 'daisy-chain' (see "[RedVision® System Setup example](#)" on [page 15](#)).

# TECHNICAL SPECIFICATIONS

Specifications are subject to change without notice.

## GENERAL SPECIFICATIONS

Main Unit Weight	355 g / 12.5 oz
Main Unit Dimensions	120 × 52 × 45 mm / 4.7" × 2" × 1.8"
Battery Sense Lead Length	1 m / 3.3'
R-Bus Cable Length	2 m / 6.6'

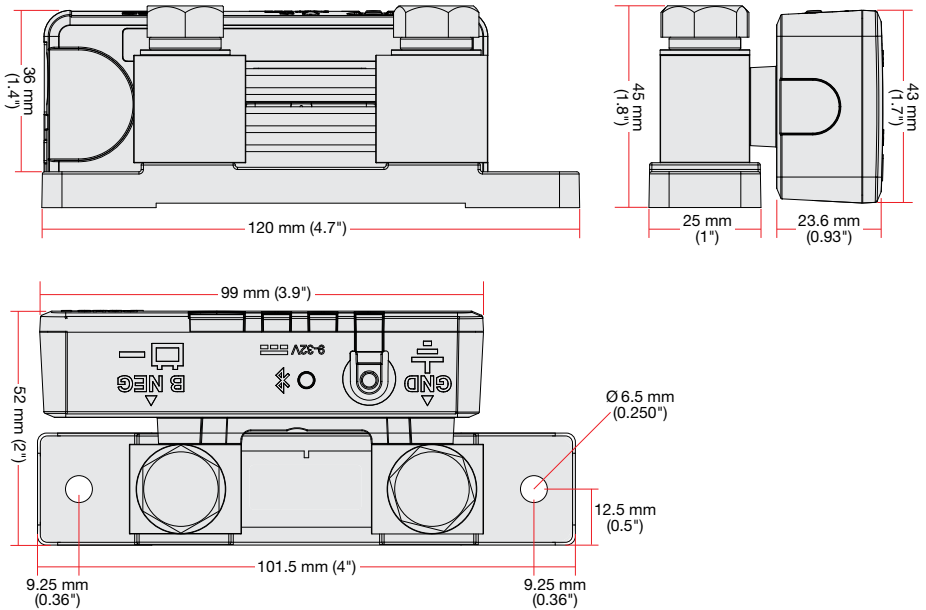



## ELECTRICAL SPECIFICATIONS

Operating Voltage Range	9–32 VDC ---	
Unit Operating Temperature	–20°C to 60°C / –4°F to 140°F	
Power Mode/Device Mode	Standalone	With R-Bus Device
Standby	2.4 mA – 3 mA	2.4 mA – 3 mA
Normal	7 mA – 14 mA	12 mA – 18 mA

Voltages Specified are  $\pm 100$  mV.

## OPERATING SPECIFICATIONS

Current Measurement Range	$\pm 500$ A
Current Measurement Accuracy	$\pm 0.3\%$ , 1–500 A @ 50°C / 122°F
Voltage Measurement Accuracy	$\pm 0.7\%$
Battery Temperature Measurement Range	–40°C to 100°C / –40°F to 212°F
Temperature Measurement Accuracy	$\pm 3^\circ\text{C}$ / $\pm 5.4^\circ\text{F}$
Battery Type	Standard Lead Acid, Calcium Content, Gel, AGM or LiFePO <sub>4</sub> type only

Voltages Specified are  $\pm 100$  mV.

## COMPLIANCE

FCC ID 2BAH6-SU601

IC 30290-SU601

Standards



### Internal Transmission Notice

1. **WARNING: Any changes or modifications not expressly approved by the grantee could void the user's authority to operate this equipment.**
2. **Note:** This equipment has been tested and found to comply with the limits for a Class B digital device, pursuant to part 15 of the FCC Rules. These limits are designed to provide reasonable protection against harmful interference in a residential installation. This equipment generates, uses and can radiate radio frequency energy and, if not installed and used in accordance with the instructions, may cause harmful interference to radio communications. However, there is no guarantee that interference will not occur in a particular installation. If this equipment does cause harmful interference to radio or television reception, which can be determined by turning the equipment off and on, the user is encouraged to try to correct the interference by one or more of the following measures:
  - Reorient or relocate the receiving antenna.
  - Increase the separation between the equipment and receiver.
  - Connect the equipment into an outlet on a circuit different from that to which the receiver is connected.
  - Consult the dealer or an experienced radio/TV technician for help
3. This device complies with Part 15 of the FCC Rules and with Innovation, Science and Economic Development Canada's licence-exempt RSS (s). Operation is subject to the following two conditions:
  - (1) This device may not cause interference.
  - (2) This device must accept any interference, including interference that may cause undesired operation of the device.

L'émetteur/récepteur exempt de licence contenu dans le présent appareil est conforme aux CNR d'Innovation, Sciences et Développement économique Canada applicables aux appareils radio exempts de licence. L'exploitation est autorisée aux deux conditions suivantes:

  - (1) L'appareil ne doit pas produire de brouillage.
  - (2) L'appareil doit accepter tout brouillage radioélectrique subi, même si le brouillard est susceptible d'en compromettre le fonctionnement
4. This equipment complies with the FCC and ISED Canada radiation exposure limits set forth for an uncontrolled environment. This equipment should be installed and operated with a minimum distance of 20 cm between the radiator and all persons during normal operation.

Cet équipement est conforme aux limites d'exposition aux rayonnements de la FCC et ISED Canada établies pour un environnement non contrôlé. Cet équipement doit être installé et utilisé avec une distance minimale de 20 cm entre le radiateur et toutes les personnes pendant le fonctionnement normal.

# WARRANTY

## LIMITED WARRANTY

For full warranty terms and conditions, visit the Warranty page of the REDARC website:

[www.redarcelectronics.com/warranty](http://www.redarcelectronics.com/warranty)

### Australia, New Zealand, UK & Europe

REDARC Electronics Pty Ltd  
23 Brodie Road (North),  
Lonsdale SA 5160  
Australia

**Australia** +61 8 8322 4848  
**New Zealand** +64 9 222 1024  
**UK & Europe** +44 (0)20 3930 8109

### North America

REDARC Corporation  
c/o Shallco, Inc.  
308 Component Dr.  
Smithfield, NC 27577  
USA

**USA** +1 (704) 247 5150  
**Canada** +1 (604) 260 5512  
**Mexico** +52 (558) 526 2898

## CHECKING THE PRODUCT SERIAL NUMBER

The Product Serial Number is located on the Battery Monitor and on the product packaging.

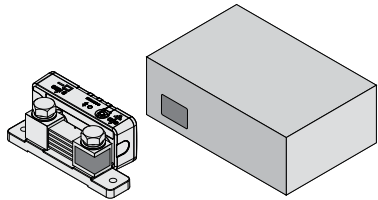

## IMPORTER CONTACT INFORMATION

### UK

Ozparts UK Ltd  
1 Prospect Place  
Pride Park  
DE24 8HG, Derby  
UK

For written request please email [power@redarcelectronics.eu](mailto:power@redarcelectronics.eu)

### Europe

Ozparts Sp. z o. o. Sp. kom.  
Slowackiego 32/5  
87-100 Torun  
Poland

**Tech Support**

1300 REDARC (1300-733-272)

**Australia**

+61 8 8322 4848

**New Zealand**

+64 9 222 1024

**UK & Europe**

+44 (0)20 3930 8109

**USA**

+1 (704) 247-5150

**Canada**

+1 (604) 260-5512

**Mexico**

+52 (558) 526-2898

**redarcelectronics.com**

THE POWER OF

